

NOTE: ALL MATERIAL COMPLIANT ROHS STANDARD

REVISION INFORMATION

Rev.	Rev. Date	Modified By	Brief Description

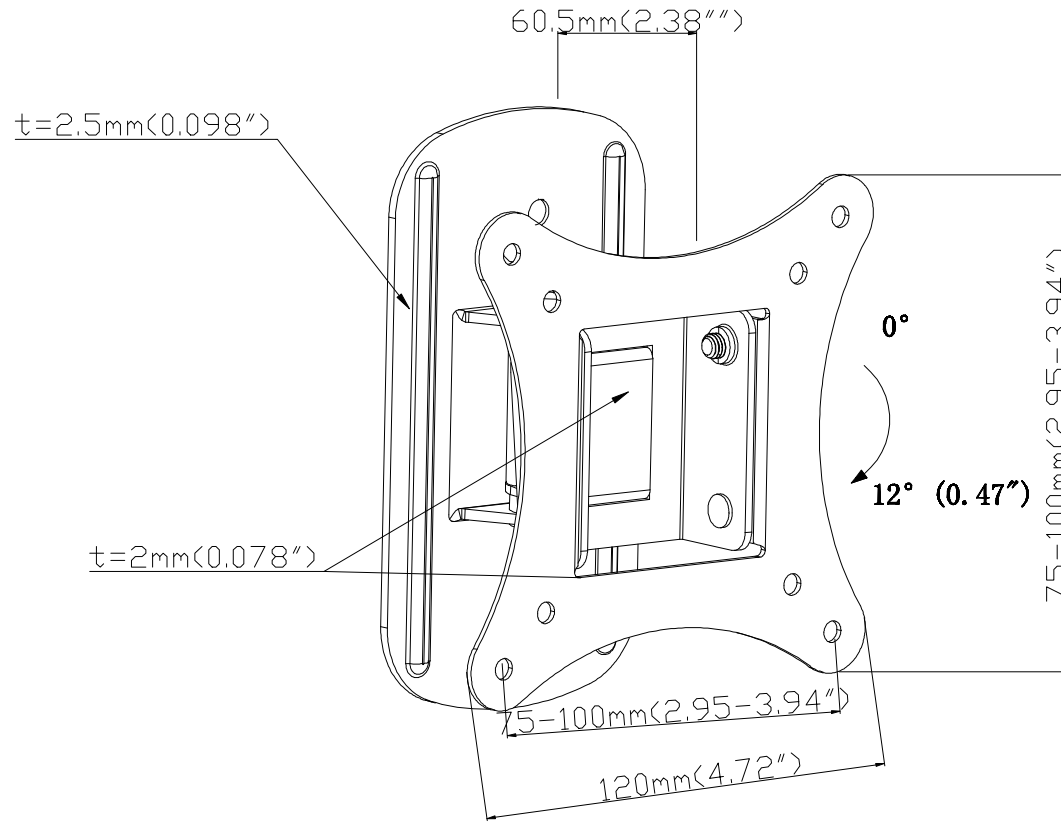

NO.	PART NAME	SPECIFICATION DESCRIPTION	QTY	UNIT
③				
②				
①				

DRAWN BY	DATE: 2012/07/06	DESCRIPTION: XXXXXXXXXXXXXXXXXXXX
CHECKED BY	SHEET 1 of 1	ITEM NO. 502829
APPROVED BY	SCALE 1:1	REV. 00 UNIT: mm